

# 10' Flat (3x3 Quads) Pop-up Assembly Instructions

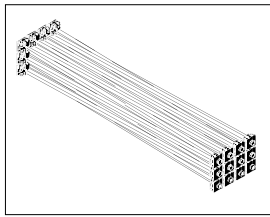

Pop-up Frame

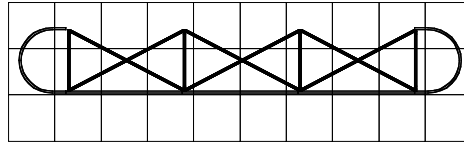
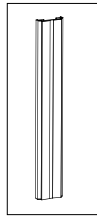

Channel Bar

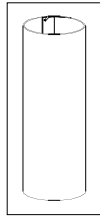

Fabric Panel

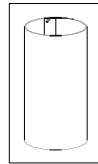

End Cap Panels

Qty.	Part
1	Pop-up frame
6	Channel bars
3	Fabric panels
2	End cap panels

**Optional parts:**  
Halogen Lights

\*Verify all parts are present according to parts list before assembling.

## Step 1

Remove Pop-up frame - Place with chrome hubs bottom front, grasping one scissors bar in each hand near Hubs spread arms up and out in a rapid motion. Lock frame in place with locking mechanism.

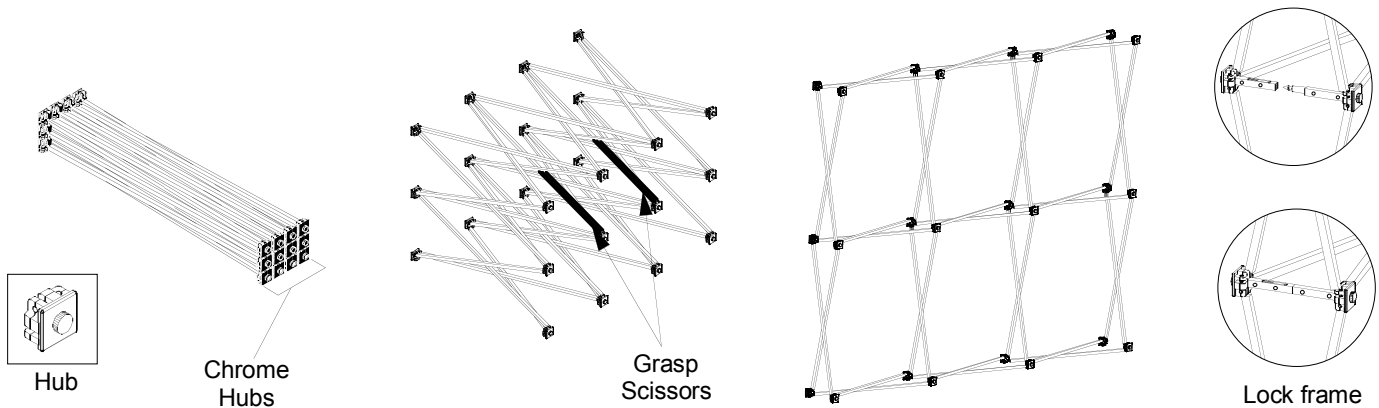

## Step 2

Remove Channel bars - unfold Channel bars and slide over hubs on the **front of frame**. Start at top hub and slide down making sure that Channel bar is secure on each hub.

Remove Channel bars - unfold Channel bars and slide over hubs on **back corner of frame** for end panels. Start at top hub and slide down making sure that Channel bar is secure on each hub.

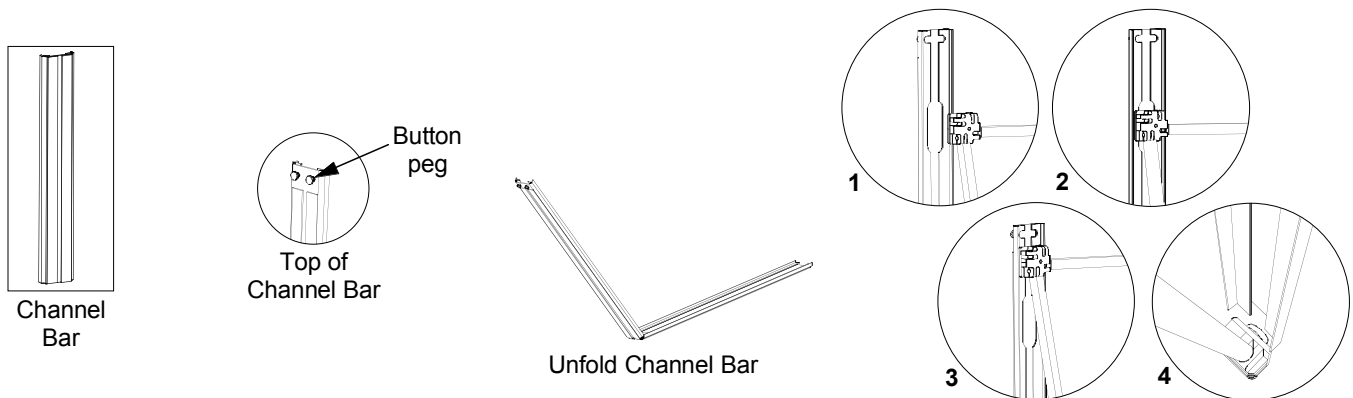

\* If your system has shelving see optional parts page before continuing.

### Step 3

Remove End cap panels - Align and place top of End cap panel on corner Channel bars, hook front and back corner on "button pegs" and smooth End cap panel from top to bottom being careful to align to center of Channel bar.

Remove Fabric panels - Locate top of Fabric panels, it will have a notched out stiffener to hang on "button pegs" on Channel bar, hang and roll Fabric panel onto Channel bar being careful to align each to center point of Channel bars.

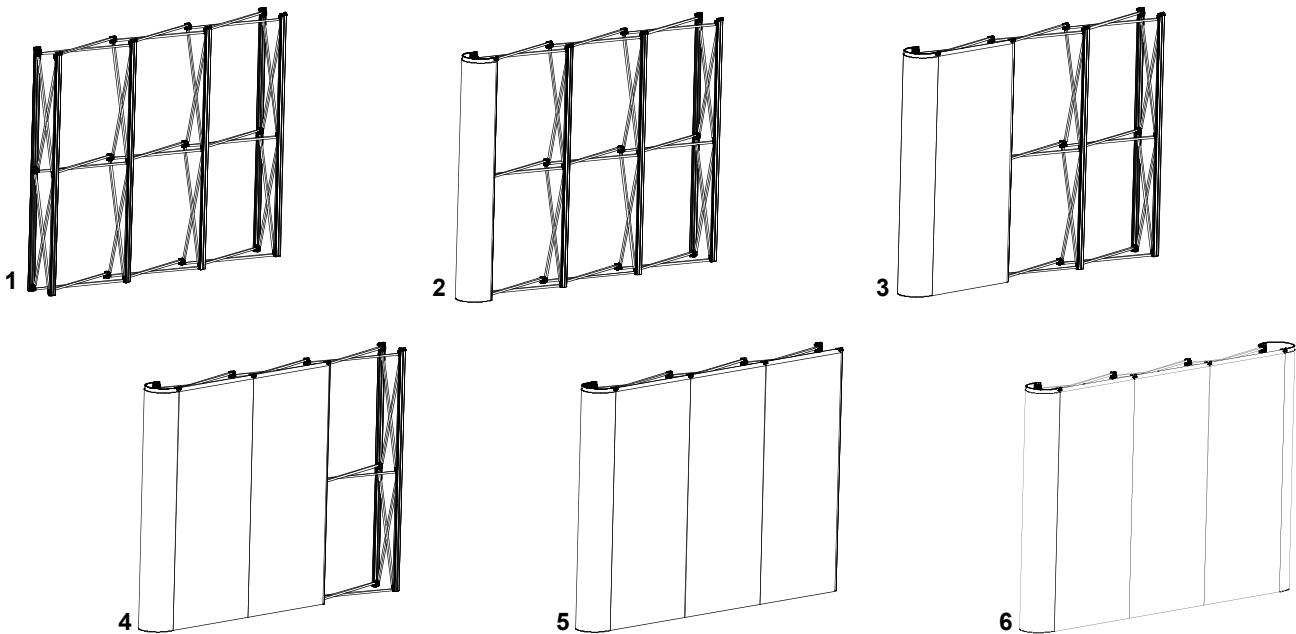
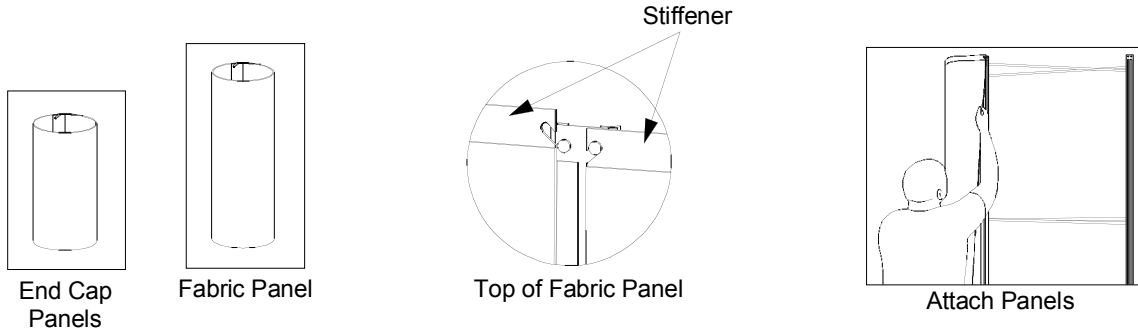

\*Install order of panels per personal preference.

### Step 4

Remove Halogen lights - Slide flange on base of light into top slot on Channel bar, adjust lighting direction.

